

为太阳能集热发电提供先进的泵解决方案  
**Cutting-edge pumping solutions for the  
concentrated solar power generation**

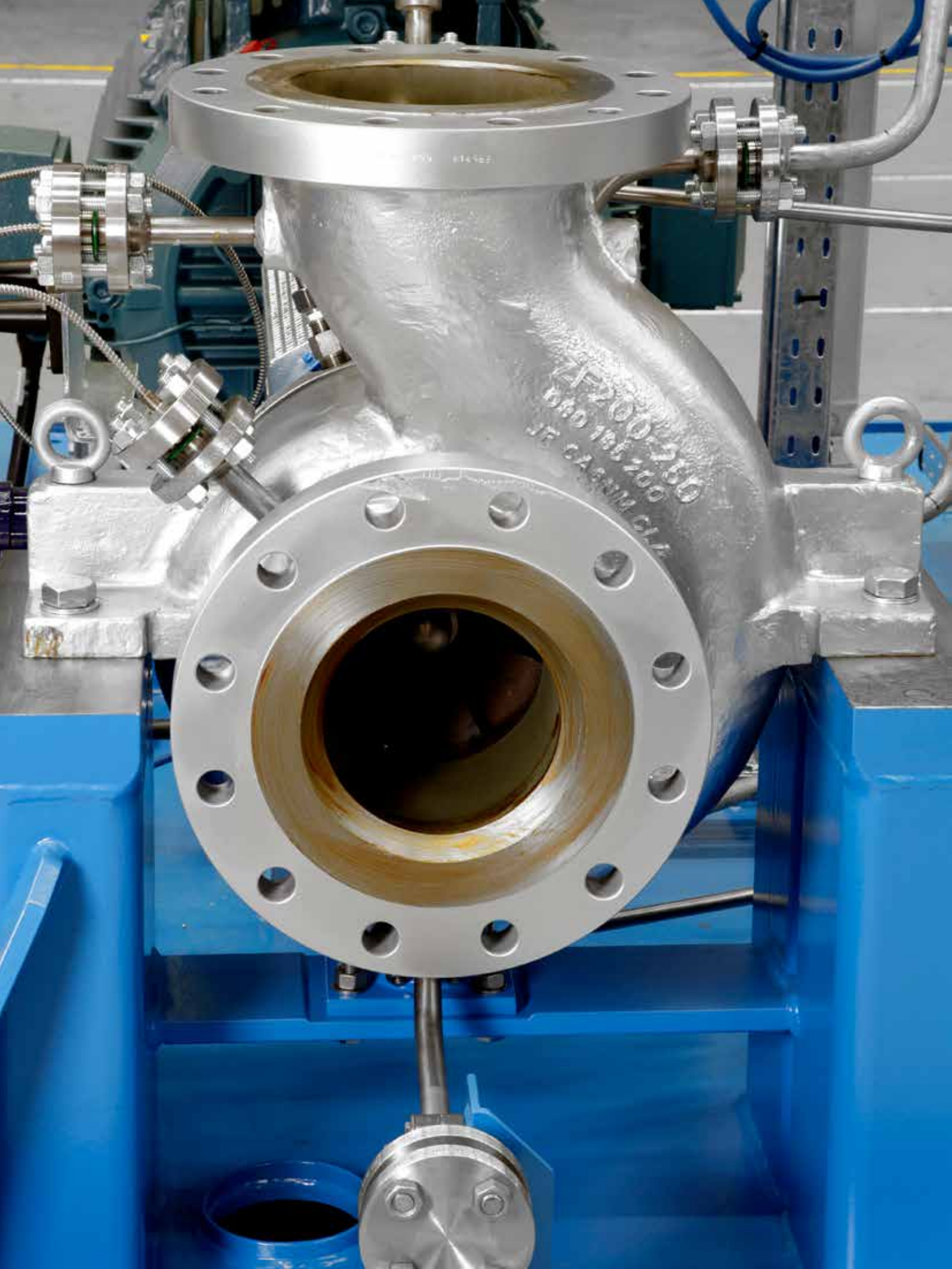



# 苏尔寿的优势

## The Sulzer advantage

### 接受新的挑战

#### Taking on new challenges

在全球范围内，电力行业面对如何利用可再生能源提供清洁、可靠能源的挑战，而太阳能集热发电（CSP）技术就为当今及未来的能源需求提供了一个可持续的解决方案。自1984年为太阳能集热发电站提供泵以来，苏尔寿与客户一同致力于为太阳能集热发电站提供可靠的低成本的产品。

*Around the world, the power industry is taking on the challenge to produce clean, dependable energy from renewable resources. Concentrated Solar Power Generation (CSP) provides a sustainable solution to energy needs, today and in the future. Sulzer has been working with customers to provide reliable and cost-effective solar power since supplying pumps to a CSP plant in 1984.*

### 根据您的需求设计

#### Designed to your needs

- 太阳能集热发电站日常启停及温度波动为发电系统中的每一个组件提出了极端的要求，而苏尔寿增加的输出功率、高的效率以及维护平均时间（MTBM）的改善为泵的解决方案提供了终身的可靠性。
- 苏尔寿能够为各种太阳能集热发电技术提供全线的产品包括给水泵、冷却水泵及凝结水泵等。
- The daily start-and-stop and temperature fluctuations in CSP operations place extreme demands on all components in a system. Sulzer provides pumping solutions that give lifetime reliability with increased output, high efficiency, and improved Mean Time Between Maintenance (MTBM)
- Sulzer answers demanding needs with a full line of steam generator feed water, cooling water and condensate extraction pumps for all CSP technologies

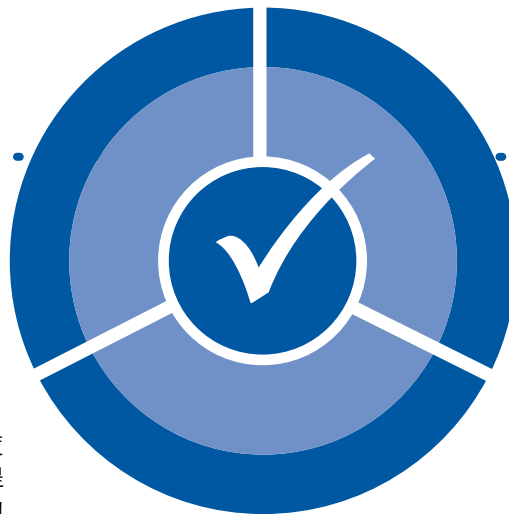

### 注重效率

#### Focused on efficiency

- 选择正确的泵是提高运营效率的一个关键因素；苏尔寿为您提供专业、有效的泵解决方案。
- 依托先进的产品，苏尔寿专注于改善客户设备的效率。
- Selecting the right pump is one key factor for boosting operational efficiency; Sulzer is the specialist to provide efficient pumping solutions
- Thanks to leading-edge products, Sulzer contributes to improve customers' equipment efficiency

### 环境改善的见证

#### Improvement of environmental footprint

- 苏尔寿高效的泵产品和服务，有助于减少碳排放总量。
- 苏尔寿的目标在于，维护在经济上的成功、健全的社会责任以及短期与长期环境友好型决策的制定之间的平衡。
- Sulzer's high efficient pumps and services contribute to reduce overall emissions
- Sulzer aims at maintaining the balance between economic success, sound social responsibility and environmentally friendly solutions in short- and long-term decision making

# 无论任何流程, 我们都能为您提供泵解决方案

## Whatever the process, we have the pumping solutions

您给我们挑战机会, 我们就可以提供解决方案。  
*You set out the challenge, we present the solutions.*

### 塔式直接蒸汽发电

通过日光反射装置将太阳能收集到中央高塔, 提供蒸汽直接发电同时提供稳定的蒸汽存储能力。苏尔寿能提供整个流程中所用的泵产品包括给水泵 (FWP)、热水循环泵 (CP)、凝结水泵 (CEP) 及冷却水泵 (CWP)。

### Heliostat with central tower and direct steam generation

Using a central solar tower, heliostat fields involve direct steam generation provided with a certain steam storage capacity. Sulzer supports these processes with pumps for Feed Water (FWP), Hot Water Circulation (CP), Condensate Extraction (CEP) and Cooling Water (CWP).

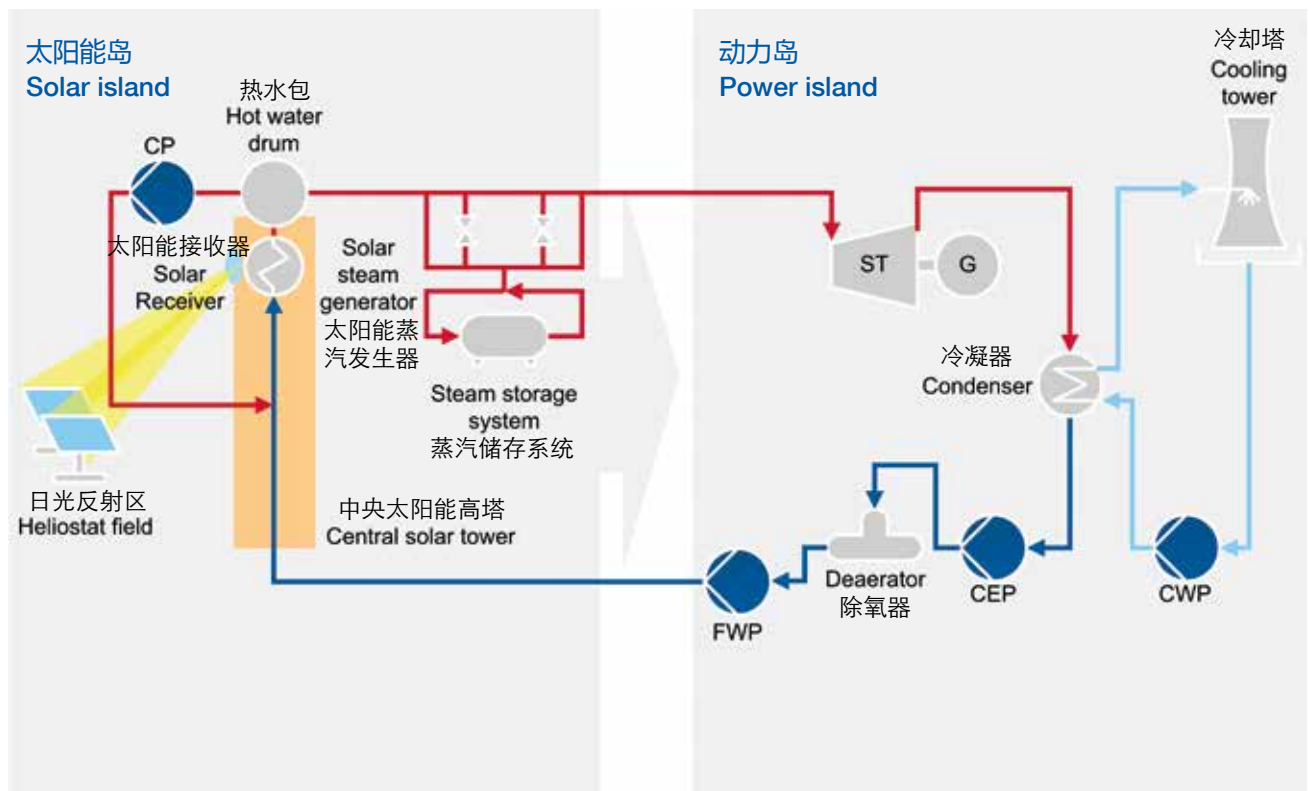

- CEP = 凝结水泵 / Condensate Extraction Pump
- CP = 热水循环泵 / Hot Water Circulation Pump
- CWP = 冷却水泵 / Cooling Water Pump
- FWP = 给水泵 / Feed Water Pump
- G = 发电机 / Generator
- ST = 蒸汽透平 / Steam Turbine

## 具有熔盐储热装置的中央高塔发电

通过日光反射装置将太阳能收集到中央高塔，提供蒸汽直接发电同时提供稳定的蒸汽存储能力。苏尔寿能提供整个流程中所用的泵产品包括给水泵 (FWP)、凝结水泵 (CEP)、冷却水泵 (CWP) 和熔盐循环泵。

## Heliostat with central tower and molten salt heat storage

Using a central solar tower, heliostat fields heat up the molten salt. The molten salt is used as primary heat transfer fluid and also to store heat generated in this process. Sulzer supports these processes with pumps for Feed Water (FWP), Condensate Extraction (CEP), Cooling Water (CWP) and Molten Salt Circulation.

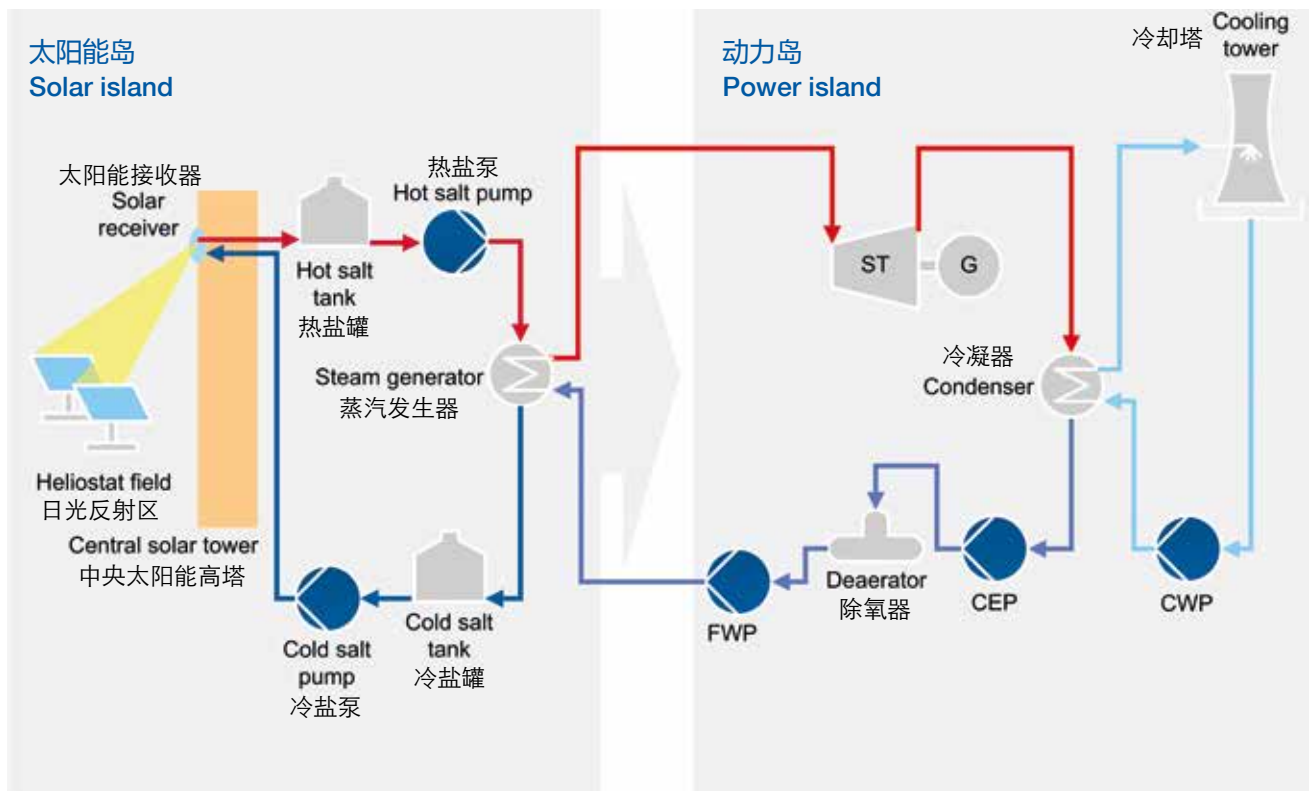

- CEP = 凝结水泵 / Condensate Extraction Pump
- CWP = 冷却水泵 / Cooling Water Pump
- FWP = 给水泵 / Feed Water Pump
- G = 发电机 / Generator
- ST = 蒸汽透平 / Steam Turbine

## 线性菲涅耳反射镜直接蒸汽发电

通过线性排列的菲涅耳反射镜，集热装置提供蒸汽直接发电同时提供稳定的蒸汽存储能力。苏尔寿能提供整个流程中所用的给水泵 (FWP)、凝结水泵 (CEP) 及冷却水泵 (CWP)。

## Linear Fresnel reflector with direct steam generation

Using linear Fresnel reflector, collectors involve direct steam generation provided with a certain steam storage. Sulzer supports these processes with pumps for Feed Water (FWP), Condensate Extraction (CEP) and Cooling Water (CWP).

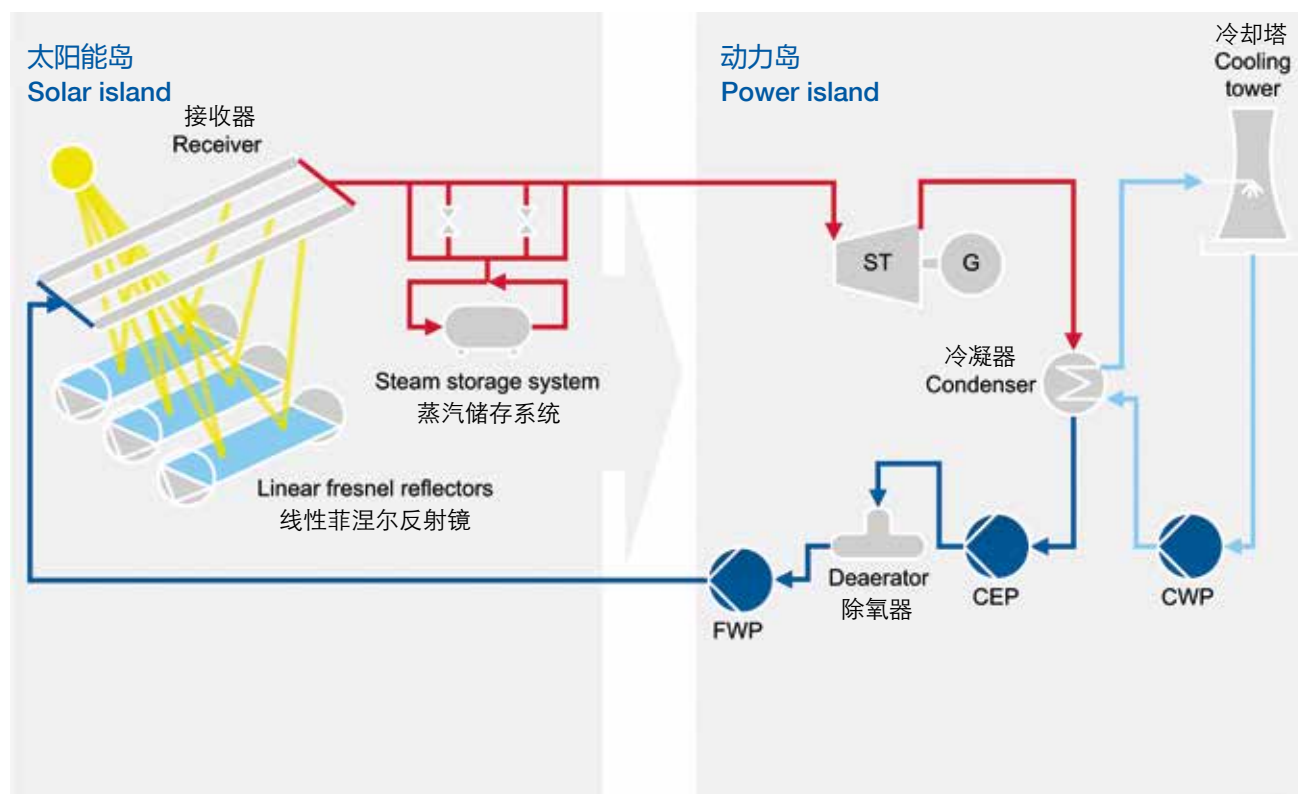

CEP = 凝结水泵 / Condensate Extraction Pump

CWP = 冷却水泵 / Cooling Water Pump

FWP = 给水泵 / Feed Water Pump

G = 发电机 / Generator

ST = 蒸汽透平 / Steam Turbine

## 带熔盐储热装置的槽式发电

槽式热量收集系统使用导热油作为最初的热载体并将熔盐加热。熔盐在整个流程中作为二次热载体用于储存热量。苏尔寿可用于这些流程的设备包括给水泵 (FWP)、凝结水泵 (CEP)、冷却水泵 (CWP)、熔盐循环等, 同时还包括主导导热油泵 (HTF) 和辅助导热油泵 (HTF)。

## Parabolic trough with molten salt heat storage

Parabolic trough collector systems are using thermal oil as primary heat transfer fluid to heat up the salt. The molten salt is used as secondary heat transfer fluid to store heat generated in this process. Sulzer equipment for these operations includes pumps for Feed Water (FWP), Condensate Extraction (CEP), Cooling Water (CWP), molten salt circulation, as well as main and auxiliary pumps for Heat Transfer Fluid (HTF).

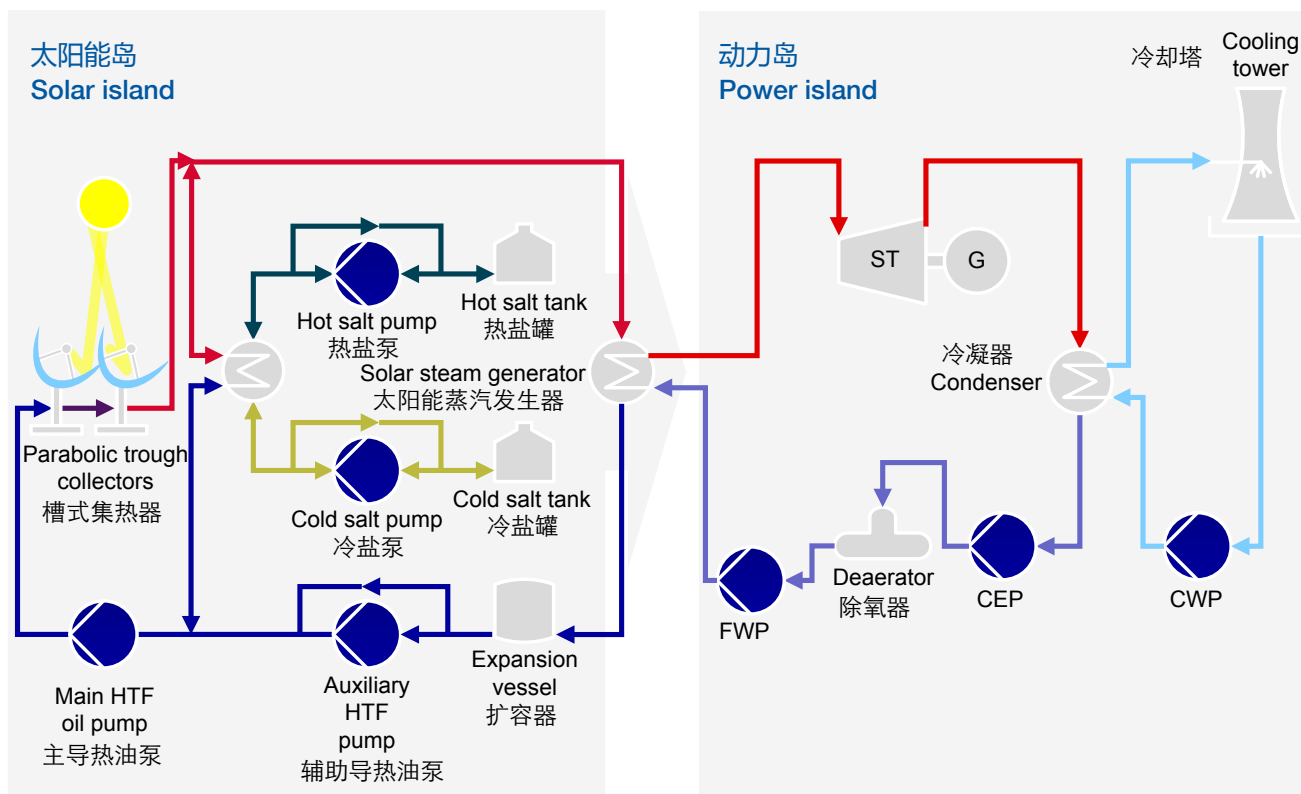

- CEP = 凝结水泵 / Condensate Extraction Pump
- CWP = 冷却水泵 / Cooling Water Pump
- FWP = 给水泵 / Feed Water Pump
- G = 发电机 / Generator
- HTF = 导热介质 / Heat Transfer Fluid
- ST = 蒸汽透平 / Steam Turbine

## 无储热装置的槽式发电

这种系统使用被加热到大约 400 度的导热油作为最初的热交换流体。导热油以不断变化的流动率和温度被泵送到太阳能区域。苏尔寿能为此类工况提供的设备有给水泵 (FWP)、凝结水泵 (CEP)、冷却水泵 (CWP)。同时还包括主导导热油泵 (HTF) 和辅助导热油泵 (HTF)。

## Parabolic trough without heat storage

This system is using thermal oil as primary heat transfer fluid heated up to around 400°C. It is continually pumped through the solar field with high and variable flow rates and temperatures. Sulzer equipment for these operations includes pumps for Feed Water (FWP), Condensate Extraction (CEP), Cooling Water (CWP) as well as main and auxiliary pumps for Heat Transfer Fluid (HTF).

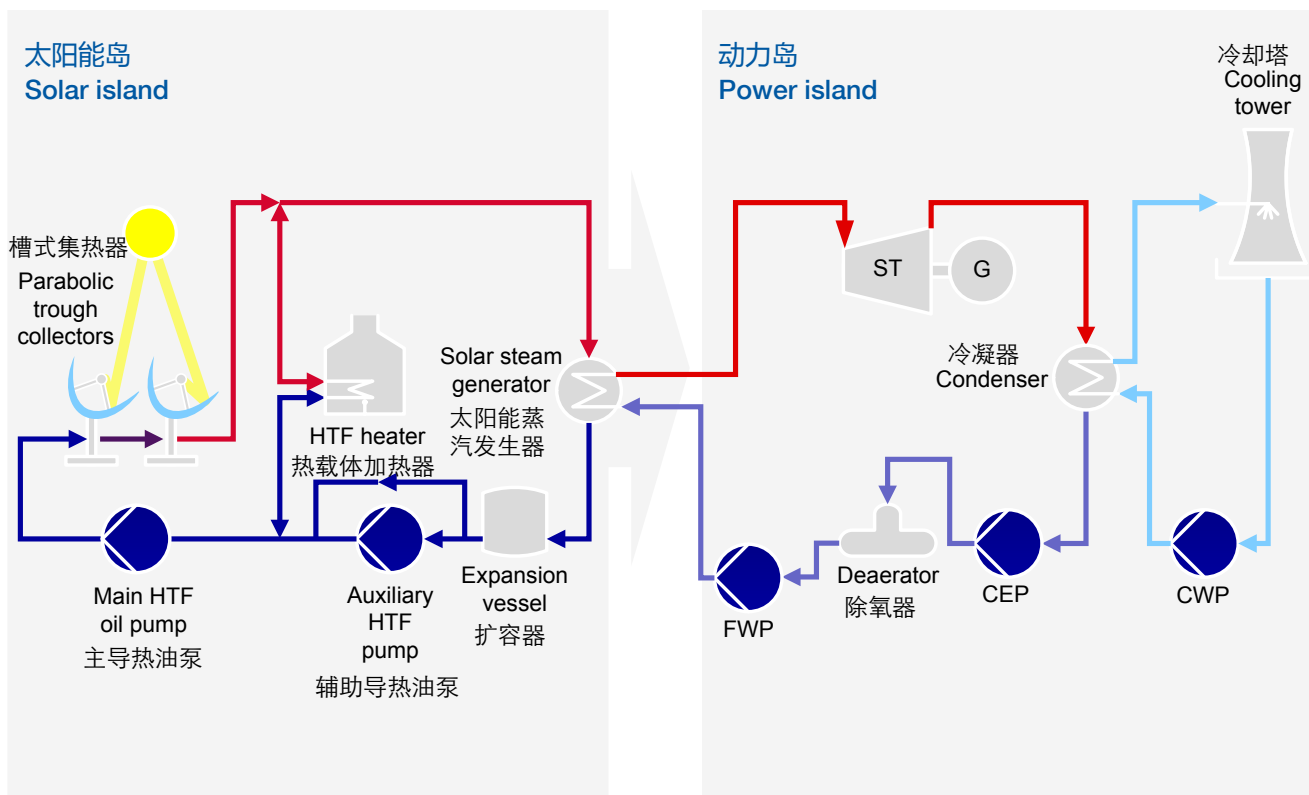

- CEP = 凝结水泵 / Condensate Extraction Pump
- CWP = 冷却水泵 / Cooling Water Pump
- FWP = 给水泵 / Feed Water Pump
- G = 发电机 / Generator
- HTF = 导热介质 / Heat Transfer Fluid
- ST = 蒸汽透平 / Steam Turbine



## 混合集成太阳能联合循环(ISCC)

这个流程使用槽式集热装置，导热油作为最初的热量传输介质。苏尔寿用于此流程的设备包括给水泵 (FWP)、凝结水泵 (CEP)、冷却水泵 (CWP)，同时还包括主导热油泵 (HTF) 和辅助导热油泵 (HTF)。

## Hybrid integrated solar combined cycle (ISCC)

This process uses parabolic trough collectors and thermal oil as primary heat transfer fluid. Sulzer equipment includes pumps for Feed Water (FWP), Condensate Extraction (CEP), Cooling Water (CWP), as well as main and auxiliary pumps for Heat Transfer Fluid (HTF).

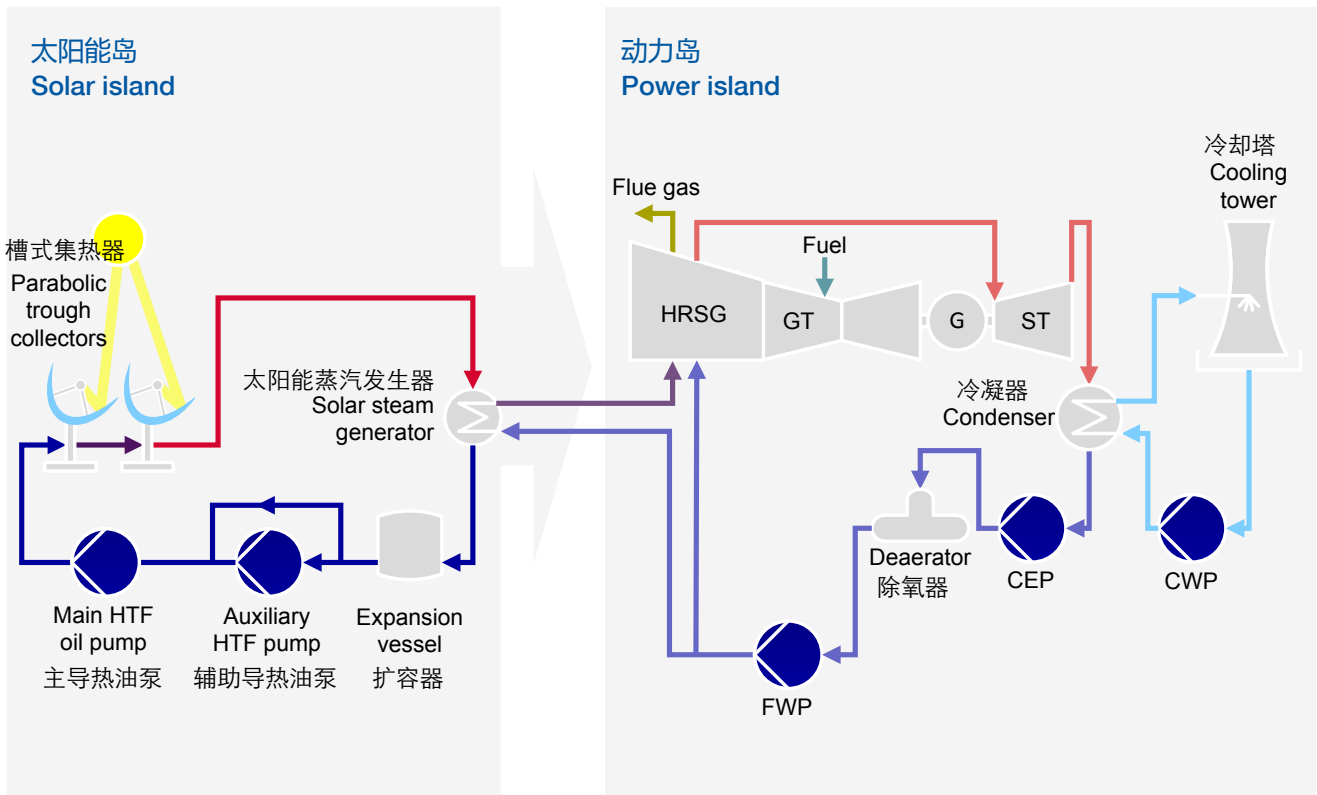

- CEP = 凝结水泵 / Condensate Extraction Pump
- CWP = 冷却水泵 / Cooling Water Pump
- FWP = 给水泵 / Feed Water Pump
- G = 发电机 / Generator
- GT = 燃气轮机 / Gas turbine
- HRSG = 余热回收蒸汽发生器 / Heat Recovery Steam Generator
- HTF = 导热介质 / Heat Transfer Fluid
- ST = 蒸汽透平 / Steam Turbine

# 您理想的服务伙伴

## Your ideal service partner

专业、负责，苏尔寿持续为您提供可靠的服务，及时的响应，快速的周转和创新的方案  
*Our expertise and commitment always deliver reliability, responsiveness, rapid turn-around and innovative solutions.*



# 我们全面的产品系列

## Our comprehensive product portfolio

电厂类型 Power plant type	应用领域 Application						
	太阳能岛 Solar island			动力岛 Power island			
	主导热油泵 HTF oil pump	熔盐泵 Molten salt pump	热水循环泵 Hot water circulation pump	给水泵 Feed Water Pump (FWP)	凝结水泵 Condensate Extraction Pump (CEP)	冷却水泵 Cooling Water Pump (CWP)	辅助泵 Auxiliary pump
泵型 Pump type							
	HZB-HTF BBS ZE/ZF OHH	VEY VNY	ZE/ZF PRER/ PRETR	MD MC MBN GSG	SJD (CEP) ZE	SJT SJM SMD SMN ZPP	AHLSTAR SNS
塔式直接蒸汽发电 Heliostat with central tower and direct steam generation		✓	✓	✓	✓	✓	✓
通过中央高塔吸收反射太阳光使熔盐融化并储存热量 Heliostat with central tower and molten salt heat storage		✓		✓	✓	✓	✓
线性菲涅耳反射镜直接蒸汽发电 Linear Fresnel reflector with direct steam generation			✓	✓	✓	✓	✓
无储热装置的槽式发电 Parabolic trough without heat storage	✓			✓	✓	✓	✓
带熔盐储热装置的槽式发电 Parabolic trough with molten salt heat storage	✓	✓		✓	✓	✓	✓
混合集成太阳能联合循环 Hybrid integrated solar combined cycle (ISCC)	✓			✓	✓	✓	✓

# 产品概述

## Product overview

太阳能岛  
Solar island

主导热油泵  
HTF oil pumps

HZB-HTF 双吸蜗壳泵  
HZB-HTF DOUBLE SUCTION VOLUTE PUMP

### 设计特点及优点 / FEATURES AND BENEFITS

- 采用中心线支撑能承受较大的热膨胀及管路载荷
- 采用最小的轴承跨距使轴的形变降到最低
- 单泵体泵盖设计以减少大修次数
- 采用具有卓越机械性能的碳钢或铬钢泵体
- 双端面机械密封确保安全运行
- Centerline mounting to allow free thermal expansion and high nozzle loads
- Minimum bearing span to minimize shaft deflection
- Single cover casing design to reduce overhaul times
- Carbon steel or chrome steel casing with excellent mechanical properties
- Double mechanical seal provides safer operation

### 主要参数 / KEY CHARACTERISTICS

流量 4'000 m<sup>3</sup>/h / 17'500 USgpm  
 扬程 达 340 m / 1'115 ft  
 压力 达 48 bar / 700 psi  
 温度 达 425°C / 800°F

Capacities 4'000 m<sup>3</sup>/h / 17'500 USgpm  
 Heads up to 340 m / 1'115 ft  
 Pressures 48 bar / 700 psi  
 Temperatures up to 425°C / 800°F

### 应用 / APPLICATIONS

- 导热油主泵
- HTF oil main pump



符合 ISO13709/API610 BB2 标准的 BBS 及 PRD 两端支撑单级泵  
 BBS BETWEEN BEARINGS SINGLE STAGE PUMPS ISO 13709 / API 610 BB2

### 设计特点及优点 / FEATURES AND BENEFITS

- 中心线支撑以减小由于热膨胀而引起的不对中
- 采用双吸叶轮以满足更小的必须汽蚀余量 (NPSHR) 值工况
- 第一临界转速大于泵正常运行时的运转速度
- 采用 2 倍于 API610 要求的管口载荷的泵体设计以避免管路形变
- 可以采用灌浆或非灌浆、1 倍或 2 倍管路载荷的底板来减少安装成本
- Centerline support for reduced thermally induced misalignment
- Double suction impeller for low Net Positive Suction Head Required (NPSHR)
- First critical speed is well above operating speed range for smooth operation
- Casing designed for 2 times API 610 nozzle loads for freedom from piping distortions
- Grouted or ungrouted, 1x or 2x nozzle load baseplates for reduced installation cost

### 主要参数 / KEY CHARACTERISTICS

流量 达 5'000 m<sup>3</sup>/h / 22'000 USgpm  
 扬程 达 450 m / 1'500 ft  
 压力 达 50 bar / 740 psi  
 温度 达 425°C / 800°F

Capacities up to 5'000 m<sup>3</sup>/h / 22'000 USgpm  
 Heads up to 450 m / 1'500 ft  
 Pressures 50 bar / 740 psi  
 Temperatures up to 425°C / 800°F

### 应用 / APPLICATIONS

- 导热油主泵
- HTF oil main pump



## ZE、ZF 及 OHH 端吸泵 ZE/ZF AND OHH END SUCTION PUMPS

### 设计特点及优点 / FEATURES AND BENEFITS

- 设计用于热水及冷水介质以及较小的装置汽蚀余量（NPSHA）值工况
- 模块化的结构设计使备件互换性最大化
- Designed for hot or cold water medium design pressure applications with relatively low Net Positive Suction Head (NPSH) available
- Modular construction to provide maximum interchangeability of spares

### 主要参数 / KEY CHARACTERISTICS

流量	达 2'600 m <sup>3</sup> /h / 11'440 USgpm
扬程	达 300 m / 1'000 ft
压力	达 100 bar / 1'450 psi
温度	达 425°C / 800°F
Capacities	up to 2'600 m <sup>3</sup> /h / 11'440 USgpm
Heads	up to 300 m / 1'000 ft
Pressures	up to 100 bar / 1'450 psi
Temperatures	up to 425°C / 800°F

### 应用 / APPLICATIONS

- 凝结水抽取
- 锅炉循环
- 导热油
- 辅助服务
- Condensate extraction
- Boiler circulation
- HTF oil
- Auxiliary services



## 熔盐泵 Molten salt pumps

### VEY和VNY立式深井泵 VEY AND VNY VERTICAL TURBINE PUMPS

### 设计特点及优点 / FEATURES AND BENEFITS

- 优秀的吸入口设计提供更低浸没深度
- 特殊的滑动轴承为轴提供更好的对中性，对热膨胀有更好的适应性
- 主密封使用喉部衬套设计，保证微量泄漏回流至熔盐罐
- 辅助挡液环密封设计防止熔盐泄漏到大气
- 冷热部件之间有效的热隔离
- 易于拆除的级间联轴器
- 为热膨胀所做的特殊设计：扩展磨损环区域，设计间隙时考虑所有相关膨胀
- Engineered suction design for optimized submergence
- Engineered bearing bushings for better shaft alignment and adaptation to the thermal expansion
- Main shaft sealing by throttle bushing for permanent leak-off recirculation to the molten salt tank
- Auxiliary shaft sealing deflector preventing leakage of molten salt to the atmosphere
- Efficient thermal barrier between hot/cold sections
- Muff coupling to ease dismantling
- Special design to allow thermal expansions: extended wear ring zone and clearances calculated considering all the relative expansions

### 主要参数 / KEY CHARACTERISTICS

流量	达 4'000 m <sup>3</sup> /h / 17'600 USgpm
扬程	达 400 m / 1'300 ft
压力	达 100 bar / 1'450 psi
温度	达 600°C / 1'100°F

Capacities	up to 4'000 m <sup>3</sup> /h / 17'600 USgpm
Heads	up to 400 m / 1'300 ft
Pressures	up to 100 bar / 1'450 psi
Temperatures	up to 600°C / 1'100°F

### 应用 / APPLICATIONS

- 熔盐
- Molten salt



## 热水循环泵 Hot water circulation pump

### ZE/ZF 及 PRER/PRETR 端吸泵 ZE/ZF AND PRER/PRETR END SUCTION PUMPS

#### 设计特点及优点 / FEATURES AND BENEFITS

- 设计用于热水及冷水介质以及较小的装置汽蚀余量（NPSHA）值工况
- 模块化的结构设计使备件互换性最大化
- Designed for hot or cold water medium design pressure applications with relatively low Net Positive Suction Head (NPSH) available
- Modular construction to provide maximum interchangeability of spares

#### 主要参数 / KEY CHARACTERISTICS

流量	达 2'600 m <sup>3</sup> /h / 11'440 USgpm
扬程	达 300 m / 1'000 ft
压力	达 300 bar / 4'350 psi
温度	达 450°C / 840°F
Capacities	up to 2'600 m <sup>3</sup> /h / 11'440 USgpm
Heads	up to 300 m / 1'000 ft
Pressures	up to 300 bar / 4'350 psi
Temperatures	up to 450°C / 840°F

#### 应用 / APPLICATIONS

- 凝结水抽取
- 锅炉循环
- 导热油
- 辅助服务
- Condensate extraction
- Boiler circulation
- HTF oil
- Auxiliary services



## 动力岛 Power island

### 给水泵 Feed water pumps

#### MD 高压节段式多级泵 MD HIGH PRESSURE STAGE CASING PUMPS

#### 设计特点及优点 / FEATURES AND BENEFITS

- 模块化的水利设计使泵在不同的运行条件下可以保持高效率
- 采用可承受较高力和力矩、低噪音值的中心支撑方式，大的管口尺寸使进口流量最优化
- 不受急速温度变化的影响
- 刚性轴的设计保证泵的临界转速大于泵最大的运行转速
- 对较大尺寸的泵，采用超级螺母简化组装及拆卸
- Modular hydraulics for high efficiency in a wide range of operating conditions
- Centerline mounted with large branch sizes for optimized inlet flow, low noise level and higher allowable forces and moments
- Unaffected by rapid temperature variations
- Stiff shaft design for critical speeds above the maximum operating speed
- Multiple screws mechanical tensioners are used on large sizes to allow simpler tightening and loosening

#### 主要参数 / KEY CHARACTERISTICS

流量	达 1'200 m <sup>3</sup> /h / 5'300 USgpm
扬程	达 2'800 m / 9'200 ft
压力	达 350 bar / 5'080 psi
温度	达 210°C / 410°F
Capacities	up to 1'200 m <sup>3</sup> /h / 5'300 USgpm
Heads	up to 2'800 m / 9'200 ft
Pressures	up to 350 bar / 5'080 psi
Temperatures	up to 210°C / 410°F

#### 应用 / APPLICATIONS

- 给水
- Feed water



**MC 高压节段式多级泵**  
**MC HIGH PRESSURE STAGE CASING PUMP**

**设计特点及优点 / FEATURES AND BENEFITS**

- 模块化的水利设计使泵在不同的运行条件下可以保持高效率
- 采用大的管口尺寸优化进口流量，降低泵噪声值以及承受较大的力和力矩
- 不受急速温度变化的影响
- 更易于泵机封冷却腔的清洗
- 刚性轴的设计保证泵的临界转速大于泵最大的运行转速
- 专用大尺寸的低压版本用于凝结水抽取应用
- Modular hydraulics for high efficiency in a wide range of operating conditions
- Large branch sizes for optimized inlet flow, low noise level and higher allowable forces and moments
- Unaffected by rapid temperature variations
- Easy access to the seal cooling chambers for cleaning
- Stiff shaft design for critical speeds above the maximum operating speed
- Low pressure version with dedicated large sizes for condensate extraction service



**主要参数 / KEY CHARACTERISTICS**

流量 达 1'700 m<sup>3</sup>/h / 8'500 USgpm  
 扬程 达 1'750 m / 5'500 ft  
 压力 达 180 bar / 2'610 psi  
 温度 达 180°C / 355°F

Capacities up to 1'700 m<sup>3</sup>/h / 8'500 USgpm  
 Heads up to 1'750 m / 5'500 ft  
 Pressures up to 180 bar / 2'610 psi  
 Temperatures up to 180°C / 355°F

**应用 / APPLICATIONS**

- 给水
- 凝结水
- Feed water
- Condensate extraction

**MBN 中压节段式多级泵**  
**MBN MEDIUM PRESSURE STAGE CASING PUMP**

**设计特点及优点 / FEATURES AND BENEFITS**

- 结构简单，优化尺寸同时减少前期投资及后期维护的成本
- 叶轮及导叶的采用高质量的铸造工艺以保证更好的效率
- 快速和简单的叶轮安装
- 在不拆卸泵前提下可以对泵轴承组件进行维护
- 泵材料范围广泛，包括双相钢材料
- Simple construction to minimize dimensions and reduce investment and maintenance costs
- High quality investment cast impellers and diffusers for better efficiency
- Fast and easy impeller mounting
- Bearing unit can be serviced without disassembling the pump
- Wide range of materials including duplex stainless steel grades



**主要参数 / KEY CHARACTERISTICS**

流量 达 700 m<sup>3</sup>/h / 3'080 USgpm  
 扬程 达 900 m / 2'950 ft  
 压力 达 100 bar / 1'450 psi  
 温度 达 180°C / 355°F

Capacities up to 700 m<sup>3</sup>/h / 3'080 USgpm  
 Heads up to 900 m / 2'950 ft  
 Pressures up to 100 bar / 1'450 psi  
 Temperatures up to 180°C / 355°F

**应用 / APPLICATIONS**

- 给水
- Feed water

**GSG 导叶式筒袋泵**  
**GSG DIFFUSER STYLE BARREL PUMP**

**设计特点及优点 / FEATURES AND BENEFITS**

- 直接驱动的功率最高达到 6MW
- 背靠背的转子设计最高可允许泵级数达到 16 级
- 宽泛的水利区间包括了多种型号
- 低压、高压、扭锁、以及高温设计适用于多种工况
- Direct drive options to 6 MW
- Back-to-back rotor stack allows up to 16 stages
- Multiple sizes cover a broad hydraulic range
- Low pressure, high pressure, twistlock, and high temperature designs suit many applications

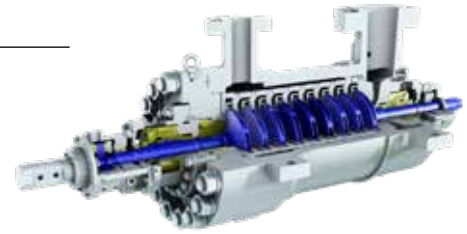

**主要参数 / KEY CHARACTERISTICS**

流量 达 900 m<sup>3</sup>/h / 4'600 USgpm  
 扬程 达 2'600 m / 10'000 ft  
 压力 达 300 bar / 4'500 psi  
 温度 达 425°C / 800°F

Capacities up to 900 m<sup>3</sup>/h / 4'600 USgpm  
 Heads up to 2'600 m / 10'000 ft  
 Pressures up to 300 bar / 4'500 psi  
 Temperatures up to 425°C / 800°F

**应用 / APPLICATIONS**

- 给水
- Feed water

**凝结水泵**  
**Condensate extraction pumps**

**SJD (CEP) 立式筒袋泵**  
**SJD (CEP) VERTICAL CAN MOUNTED TURBINE TYPE PUMP**

**设计特点及优点 / FEATURES AND BENEFITS**

- 导流壳和中间接管中碳石墨产品自润滑的轴承有更长的免维护周期
- 可拆卸密封腔允许在不拆卸进出口段的情况下维护保养节流衬套 独立焊接的电机支架允许每个泵型号采用同一进出口段
- 中间节联轴器允许根据需要维护机械密封和推力轴承
- 筒体提供横向及抗涡旋的筋板确保沿着筒体方向有着相同的流速
- 首级叶轮水力可提供多种选择，包括双吸叶轮选项以实现泵的尺寸最佳
- Carbon graphite product lubricated bearing in bowls and columns for long maintenance-free periods
- Removable seal housing allows servicing throttle bushing without removing the head
- Separate fabricated driver stand allows using one suction and discharge head per pump size
- Spacer coupling allows servicing the mechanical seal and thrust bearing as needed
- Can is provided with lateral and anti-rotational ribs uniform inlet velocity along the can length
- Various options available for the first stage impeller hydraulics, including double suction impeller allowing optimum sizing of pump

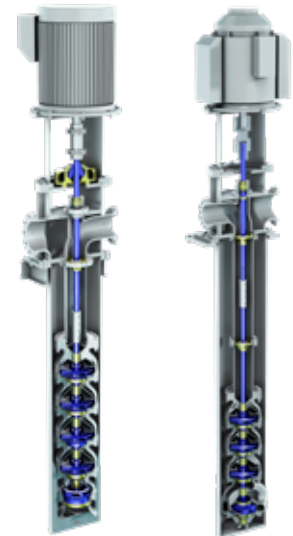

**主要参数 / KEY CHARACTERISTICS**

流量 达 4'900 m<sup>3</sup>/h / 21'560 USgpm  
 扬程 达 400 m / 1'300 ft  
 压力 达 94 bar / 1'360 psi  
 温度 达 100°C / 212°F

Capacities up to 4'900 m<sup>3</sup>/h / 21'560 USgpm  
 Heads up to 400 m / 1'300 ft  
 Pressures up to 94 bar / 1'360 psi  
 Temperatures up to 100°C / 212°F

**应用 / APPLICATIONS**

- 高压凝结水泵
- High pressure condensate extraction



**ZE 端吸泵**  
**ZE END SUCTION PUMP**

**设计特点及优点 / FEATURES AND BENEFITS**

- 设计用于热水及冷水介质以及较小的装置汽蚀余量 (NPSHA) 工况
- 模块化的结构设计使备件互换性最大化
- Designed for hot or cold water medium design pressure applications with relatively low Net Positive Suction Head (NPSH) available
- Modular construction to provide maximum interchangeability of spares

**主要参数 / KEY CHARACTERISTICS**

流量	达 2'600 m <sup>3</sup> /h / 11'440 USgpm
扬程	达 300 m / 1'000 ft
压力	达 100 bar / 1'450 psi
温度	达 425°C / 800°F
Capacities	up to 2'600 m <sup>3</sup> /h / 11'440 USgpm
Heads	up to 300 m / 1'000 ft
Pressures	up to 100 bar / 1'450 psi
Temperatures	up to 425°C / 800°F

**应用 / APPLICATIONS**

- 凝结水抽取
- 锅炉循环
- 导热油
- 辅助服务
- Condensate extraction
- Boiler circulation
- HTF oil
- Auxiliary services



**冷却水泵**  
**Cooling water pumps**

**SJT 立式涡轮泵及 SJM 立式混流泵**  
**SJT VERTICAL TURBINE PUMP AND SJM VERTICAL MIXED FLOW PUMP**

**设计特点及优点 / FEATURES AND BENEFITS**

- 优化的水利设计使泵效率最大化
- 采用填料密封提供可靠的轴封且易于维护，也可采用机械密封
- 在入口及筒体内采用橡胶内衬的自润滑轴承，可以长时间免维护，同时也可选择其他材质的轴承
- 采用中间节便于机械密封及推力轴承的维修
- Optimized hydraulics for high efficiency
- Packed stuffing box for reliable sealing and simple maintenance; mechanical seal is optional
- Rubber-lined product-lubricated bearing in bowls and columns for long maintenance-free periods; other bearing materials also available
- Spacer coupling allows servicing of the seal and thrust bearing as required

**主要参数 / KEY CHARACTERISTICS**

流量	达 62'000 m <sup>3</sup> /h / 270'000 USgpm
扬程	达 110 m 每级 / 350 ft 每级
压力	达 64 bar / 930 psi
温度	达 50°C / 120°F
Capacities	up to 62'000 m <sup>3</sup> /h / 270'000 USgpm
Heads	up to 110 m per stage / 350 ft per stage
Pressures	up to 64 bar / 930 psi
Temperatures	up to 50°C / 120°F

**应用 / APPLICATIONS**

- 冷却水泵
- 辅助服务
- Cooling water pumps
- Auxiliary services



**SMD 及 SMN 径向剖分式双吸泵**  
**SMD AND SMN AXIALLY SPLIT CASING DOUBLE SUCTION PUMPS**

**设计特点及优点 / FEATURES AND BENEFITS**

- 拥有多种水利设计以保证泵在很大的流量范围内仍具有高效率
- 在最优效率点及超载的工况下都有较低的必须汽蚀余量 (NPSHR) 值
- 易于维修, 卓越的部件互换性
- 水平及立式的结构
- Optimum hydraulic fit with high efficiency maintained over a wider flow range
- Exceptionally low Net Positive Suction Head Required (NPSHR) value not only at the best efficiency point but also on overload
- Maintenance-friendly features; excellent interchangeability of parts
- Horizontal and vertical constructions

**主要参数 / KEY CHARACTERISTICS**

流量	达 25'000 m <sup>3</sup> /h / 110'000 USgpm
扬程	达 260 m / 850 ft
压力	达 34 bar / 490 psi
温度	达 140°C / 280°F
Capacities	up to 25'000 m <sup>3</sup> /h / 110'000 USgpm
Heads	up to 260 m / 850 ft
Pressures	up to 34 bar / 490 psi
Temperatures	up to 140°C / 280°F

**应用 / APPLICATIONS**

- 冷却水泵
- 辅助服务
- Cooling water pumps
- Auxiliary services



**ZPP 双吸轴向剖分单级泵**  
**ZPP DOUBLE SUCTION AXIALLY SPLIT SINGLE STAGE PUMP**

**设计特点及优点 / FEATURES AND BENEFITS**

- 达到并超过 ISO5199 要求
- 独特专利优化设计减少周期维护成本
- 快速简便的安装, 运行可靠, 容易维护及保养
- Exceeds requirements of international ISO 5199 standard
- Unique, patented and superior design features minimize life cycle costs
- Quick and easy installation, reliable operation, easy maintenance and service

**主要参数 / KEY CHARACTERISTICS**

流量	达 25'000 m <sup>3</sup> /h / 110'000 USgpm
扬程	达 160 m / 525 ft
压力	达 20 bar / 290 psi
温度	达 120°C / 250°F
Capacities	up to 25'000 m <sup>3</sup> /h / 110'000 USgpm
Heads	up to 160 m / 525 ft
Pressures	up to 20 bar / 290 psi
Temperatures	up to 120°C / 250°F

**应用 / APPLICATIONS**

- 冷却水泵
- 辅助服务
- Cooling water pumps
- Auxiliary services



## 辅助泵 Auxiliary pump

### AHLSTAR 单级离心泵 AHLSTAR END SUCTION SINGLE STAGE LONG COUPLED CENTRIFUGAL PUMP

#### 设计特点及优点 / FEATURES AND BENEFITS

- 选用高于相应的 ISO5199 及 ISO2858 国际标准
- 适用于多种苛刻的工业应用
- 独特的、拥有专利的优化设计以减少泵的生命周期维护成本
- 快捷的安装、可靠的运行以及简便的维护及服务
- Exceeds standard requirements of international ISO 5199 and ISO 2858 standards
- Suitable for the most demanding industrial applications
- Unique, patented and superior design features minimize life cycle costs
- Quick and easy installation, reliable operation, easy maintenance and service

#### 主要参数 / KEY CHARACTERISTICS

流量	达 11'000 m <sup>3</sup> /h / 48'400 USgpm
扬程	达 160 m / 525 ft
压力	达 25 bar / 360 psi
温度	达 180°C / 355°F

Capacities	up to 11'000 m <sup>3</sup> /h / 48'400 USgpm
Heads	up to 160 m / 525 ft
Pressures	up to 25 bar / 360 psi
Temperatures	up to 180°C / 355°F

#### 应用 / APPLICATIONS

- 冷却水泵
- 辅助服务
- Cooling water pumps
- Auxiliary services



### SNS 端吸单级离心泵 SNS END SUCTION SINGLE STAGE CENTRIFUGAL PUMP

#### 设计特点及优点 / FEATURES AND BENEFITS

- 设计符合 EN ISO 5199 国际标准的设计要求
- 超过欧盟 (EU) 对能源相关产品 (ErP) 的要求
- 整个泵系列的效率最高, 超过基准效率指数 MEI 0.7 (最低效率指数)
- 全新的最先进的水力设计确保在低的必须汽蚀余量 (NPSHr) 下提供最佳的流量
- 低能耗, 高标准化, 易于安装和独特的结构等同于降低维护和运营成本
- Designed to meet the design requirement of EN ISO 5199 international standard
- Exceeding EU's (European Union) requirements for energy-related products (ErP)
- Highest efficiency across the whole pump range, exceeding the benchmark efficiency index MEI 0.7 (Minimum Efficiency Index)
- New, state-of-the art hydraulics ensure optimum capacity with low net positive suction head required (NPSHr)
- Low energy consumption, high standardization, easy installation and unique construction also equate to lower maintenance and operating costs

#### 主要参数 / KEY CHARACTERISTICS

流量	达 1'400 m <sup>3</sup> /h / 6'000 USgpm
扬程	达 160 m / 525 ft
压力	达 16 bar / 230 psi
温度	达 120°C / 250°F

Capacities	up to 1'400 m <sup>3</sup> /h / 6'000 USgpm
Heads	up to 160 m / 525 ft
Pressures	up to 16 bar / 230 psi
Temperatures	up to 120°C / 250°F

#### 应用 / APPLICATIONS

- 辅助服务
- Auxiliary services



想要了解更多的信息，请联系 [power@sulzer.com](mailto:power@sulzer.com)

For more information, please contact [power@sulzer.com](mailto:power@sulzer.com)

[www.sulzer.com](http://www.sulzer.com)



E10052 zh en 6.2018, 版权所有©苏尔寿 Copyright © Sulzer Ltd 2018

本只是个梗概介绍，它不提供任何种类的授权和担保。如想要获得我们产品授权和担保的描述，请与我们联系。此中的所有信息 在没有通知的情况下会随时更改。

This brochure is a general presentation. It does not provide any warranty or guarantee of any kind. Please, contact us for a description of the warranties and guarantees offered with our products. Directions for use and safety will be given separately. All information herein is subject to change without notice.